

SAC-4P-M12MS/ 5,0-PUR/M12FS - Sensor/actuator cable



1694075

<https://www.phoenixcontact.com/in/products/1694075>

Please be informed that the data shown in this PDF document is generated from our Online Catalog. Please find the complete data in the user documentation. Our General Terms of Use for Downloads are valid.



Sensor/actuator cable, 4-position halogen-free, Plug straight M12, coding: A, on Socket straight M12, coding: A, cable length: 5 m

Commercial Data

Item number	1694075
Packing unit	1 pc
Minimum order quantity	1 pc
Sales Key	BF1
Product Key	BF1CCA
GTIN	4017918452841
Weight per Piece (including packing)	145.933 g
Weight per Piece (excluding packing)	140.5 g
Customs tariff number	85444290
Country of origin	DE

SAC-4P-M12MS/ 5,0-PUR/M12FS - Sensor/actuator cable



1694075

<https://www.phoenixcontact.com/in/products/1694075>

Technical Data

Product properties

Product type	Sensor/actuator cable
Number of positions	4
No. of cable outlets	1
Shielded	no
Coding	A

Insulation characteristics

Overvoltage category	II
Degree of pollution	3

Material specifications

Flammability rating according to UL 94	HB
Seal material	NBR
Material of grip body	TPU, hardly inflammable, self-extinguishing
Contact material	CuSn
Contact surface material	Ni/Au
Contact carrier material	TPU GF
Material for screw connection	Zinc die-cast, nickel-plated

Electrical properties

Contact resistance	$\leq 5 \text{ m}\Omega$
Insulation resistance	$\geq 100 \text{ M}\Omega$
Nominal voltage U_N	250 V AC
	250 V DC
Nominal current I_N	4 A

Mechanical properties

Mechanical data

Insertion/withdrawal cycles	≥ 100
-----------------------------	------------

Signaling

Status display	No
Status display present	No

Connection data

Conductor connection

Tightening torque	0.4 Nm
-------------------	--------

Connector

Connection 1

SAC-4P-M12MS/ 5,0-PUR/M12FS - Sensor/actuator cable

1694075

<https://www.phoenixcontact.com/in/products/1694075>

Type	Plug straight M12
Number of positions	4
Coding type	A

Connection 2

Type	Socket straight M12
Number of positions	4
Coding type	A

Cable/line

Cable length	5 m
--------------	-----

PUR halogen-free black [PUR]

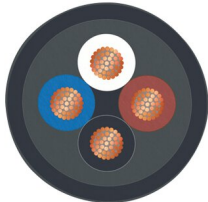
Dimensional drawing	
Cable weight	30 kg/km
UL AWM Style	20549 / 10493 (80°C/300 V)
Number of positions	4
Shielded	no
Cable type	PUR halogen-free black [PUR]
Conductor structure signal line	42x 0.10 mm
AWG signal line	22
Conductor cross section	4x 0.34 mm ² (Signal line)
Wire diameter incl. insulation	1.27 mm ±0.02 mm
External cable diameter	4.2 mm ±0.15 mm
Outer sheath, material	PUR
External sheath, color	black-gray RAL 7021
Conductor material	Bare Cu litz wires
Material wire insulation	PP
Single wire, color	brown, white, blue, black
Thickness, insulation	≥ 0.21 mm
Thickness, outer sheath	approx. 0.5 mm
Overall twist	4 wires, twisted
Max. conductor resistance	≤ 58 Ω/km
Insulation resistance	≥ 1 GΩ*km
Nominal voltage, cable	≤ 300 V
Test voltage	≥ 3000 V
Minimum bending radius, fixed installation	5 x D
Minimum bending radius, flexible installation	10 x D

SAC-4P-M12MS/ 5,0-PUR/M12FS - Sensor/actuator cable



1694075

<https://www.phoenixcontact.com/in/products/1694075>

Max. bending cycles	10000000
Halogen-free	in accordance with DIN VDE 0472 part 815
	in accordance with DIN EN 50267-2-1
Flame resistance	in accordance with UL 758/1581 FT2
	DIN EN 60332-2-2 (20 s)
Resistance to oil	in accordance with DIN EN 60811-2-1
Other resistance	Highly resistant to acids, alkaline solutions and solvents
	hydrolysis and microbe resistant
	partly UV-resistant in accordance with DIN EN ISO 4892-2-A
	Low adhesion
Special properties	abrasion-resistant
	Flexible cable conduit capable
	Silicone-free
	Free of substances which would hinder coating with paint or varnish
Ambient temperature (operation)	flexible
	-40 °C ... 80 °C (cable, fixed installation)
	-25 °C ... 80 °C (Cable, flexible installation)

Environmental and real-life conditions

Ambient conditions

Degree of protection	IP65
	IP67
	IP68
Ambient temperature (operation)	-25 °C ... 90 °C (Plug / socket)
	-40 °C ... 80 °C (cable, fixed installation)
	-5 °C ... 80 °C (Cable, flexible installation)

SAC-4P-M12MS/ 5,0-PUR/M12FS - Sensor/actuator cable



1694075

<https://www.phoenixcontact.com/in/products/1694075>

Drawings

Schematic diagram

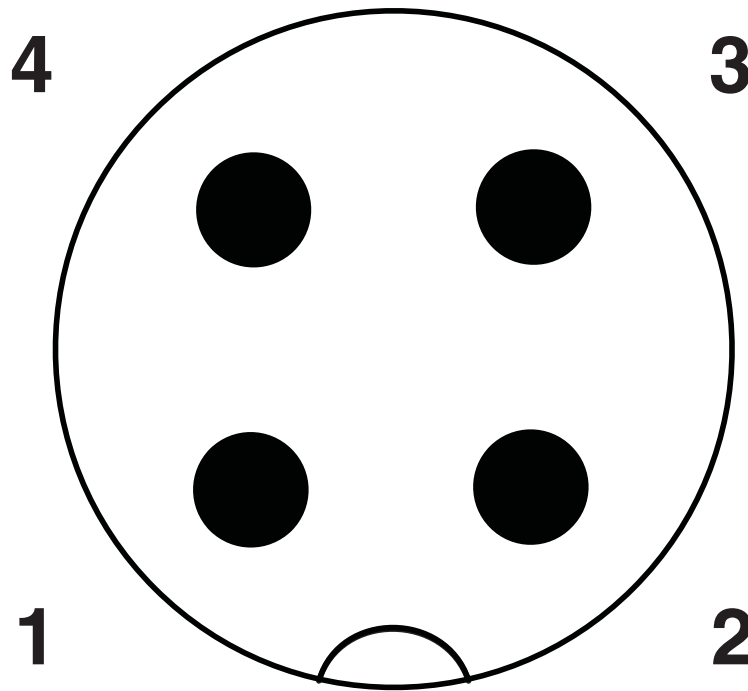

Pin assignment M12 plug, 4-pos., A-coded, view plug side

Circuit diagram

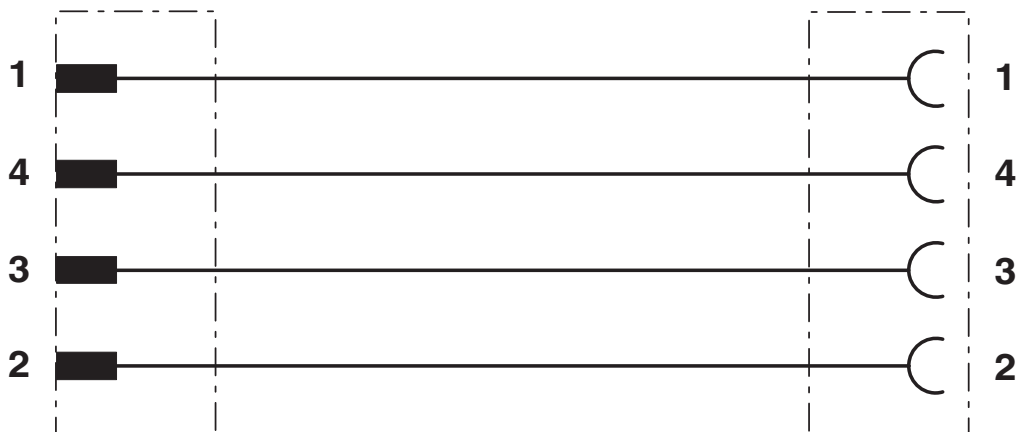

SAC-4P-M12MS/ 5,0-PUR/M12FS - Sensor/actuator cable

1694075

<https://www.phoenixcontact.com/in/products/1694075>

Dimensional drawing

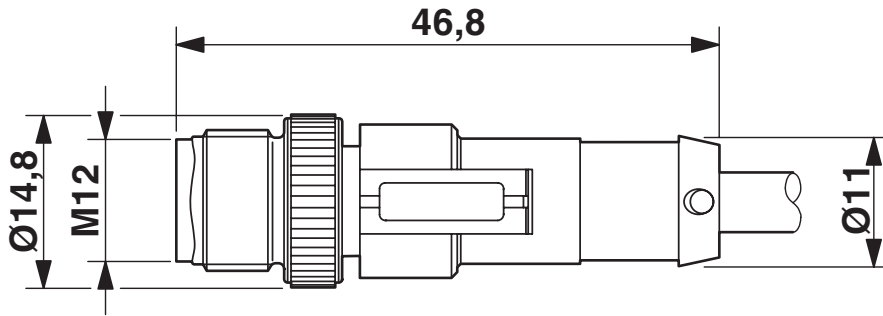

Plug, M12 x 1, straight, shielded

Dimensional drawing

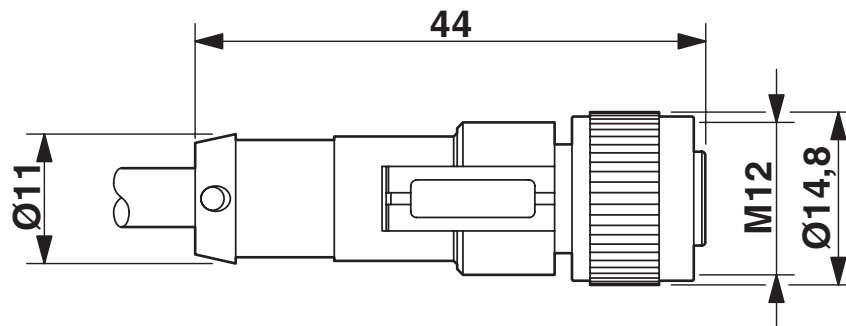

M12 x 1 socket, straight

SAC-4P-M12MS/ 5,0-PUR/M12FS - Sensor/actuator cable

1694075

<https://www.phoenixcontact.com/in/products/1694075>

Schematic diagram

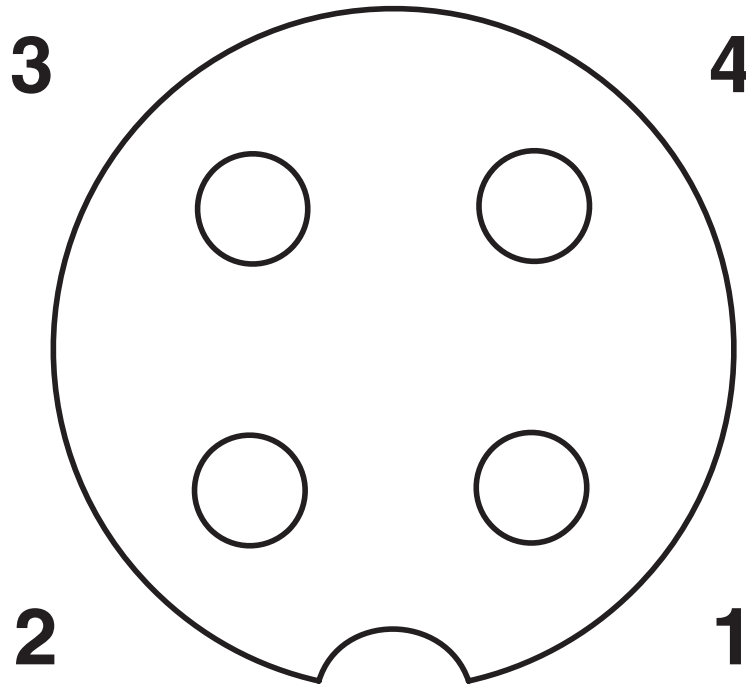

Pin assignment M12 socket, 4-pos., A-coded, view female side

SAC-4P-M12MS/ 5,0-PUR/M12FS - Sensor/actuator cable



1694075

<https://www.phoenixcontact.com/in/products/1694075>

Approvals



EAC

Approval ID: RU C-DE.BL08.B.00286



UL Listed

Approval ID: FILE E 221474

	Nominal Voltage U_N	Nominal Current I_N	Cross Section AWG	Cross Section mm^2
	300 V	4 A	-	-



cUL Listed

Approval ID: FILE E 221474

	Nominal Voltage U_N	Nominal Current I_N	Cross Section AWG	Cross Section mm^2
	300 V	4 A	-	-



EAC

Approval ID: RU D-DE.HB35.B.00387

SAC-4P-M12MS/ 5,0-PUR/M12FS - Sensor/actuator cable



1694075

<https://www.phoenixcontact.com/in/products/1694075>

Classifications

ECLASS

ECLASS-11.0	27060311
ECLASS-12.0	27060311
ECLASS-13.0	27060311

ETIM

ETIM 8.0	EC001855
----------	----------

UNSPSC

UNSPSC 21.0	26121600
-------------	----------

SAC-4P-M12MS/ 5,0-PUR/M12FS - Sensor/actuator cable



1694075

<https://www.phoenixcontact.com/in/products/1694075>

Environmental Product Compliance

China RoHS	Environmentally friendly use period: unlimited = EFUP-e
	No hazardous substances above threshold values

SAC-4P-M12MS/ 5,0-PUR/M12FS - Sensor/actuator cable



1694075

<https://www.phoenixcontact.com/in/products/1694075>

Accessories

PROT-M12 FS-PA-CHAIN - Sealing cap

1430873

<https://www.phoenixcontact.com/in/products/1430873>

M12 sealing cap made of plastic with fixing band, for sensor cables, for free M12 plugs



SAC-M12-EXCLIP-M - Locking clip

1558988

<https://www.phoenixcontact.com/in/products/1558988>

Locking clip for the pin side of sensor/actuator cables with M12 connector and M12 connectors for assembly, for knurl diameter: 15 mm or for Allen key with a wrench size of 14 mm, prevents the disconnection of plug-in connections without tools



SAC-4P-M12MS/ 5,0-PUR/M12FS - Sensor/actuator cable



1694075

<https://www.phoenixcontact.com/in/products/1694075>

PABA WH/23 - Insert label

1013779

<https://www.phoenixcontact.com/in/products/1013779>



Insert label, Strip, white, unlabeled, can be labeled with: CMS-P1-PLOTTER, mounting type: slide-on, cable diameter range: 1.5 ... 35 mm, lettering field size: 23 x 4 mm, Number of individual labels: 20

PABA YE/23 - Insert label

1013782

<https://www.phoenixcontact.com/in/products/1013782>

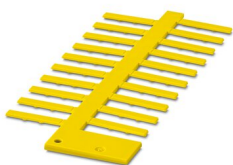

Insert label, Strip, yellow, unlabeled, can be labeled with: CMS-P1-PLOTTER, mounting type: slide-on, cable diameter range: 1.5 ... 35 mm, lettering field size: 23 x 4 mm, Number of individual labels: 20

SAC-4P-M12MS/ 5,0-PUR/M12FS - Sensor/actuator cable



1694075

<https://www.phoenixcontact.com/in/products/1694075>

B-STIFT - Marker pen

1051993

<https://www.phoenixcontact.com/in/products/1051993>



Marker pen, for manual labeling of unprinted Zack strips, smear-proof and waterproof, line thickness 0.5 mm

PROT-M12 MS-PA-CHAIN - Screw plug

1430899

<https://www.phoenixcontact.com/in/products/1430899>

M12 sealing cap with fixing band, for sensor cables, for free M12 sockets



SAC-4P-M12MS/ 5,0-PUR/M12FS - Sensor/actuator cable



1694075

<https://www.phoenixcontact.com/in/products/1694075>

SAC-M12-EXCLIP-F - Locking clip

1558991

<https://www.phoenixcontact.com/in/products/1558991>



Locking clip for the socket side of sensor/actuator cables with M12 connector and M12 connectors for assembly, for knurl diameter: 15 mm or for Allen key with a wrench size of 14 mm, prevents the disconnection of plug-in connections without tools

TSD 04 SAC - Torque screwdriver

1208429

<https://www.phoenixcontact.com/in/products/1208429>



Torque screwdriver, with preset torque of 0.4 Nm and 4 mm hexagonal drive for M12 connectors

SAC-4P-M12MS/ 5,0-PUR/M12FS - Sensor/actuator cable



1694075

<https://www.phoenixcontact.com/in/products/1694075>

TSD-M 1,2NM - Torque screwdriver

1212224

<https://www.phoenixcontact.com/in/products/1212224>



Torque screw driver, accuracy as per EN ISO 6789 standard, adjustable from 0.3 - 1.2 Nm

TSD-M SAC-BIT ADAPTER - Adapter insert

1212600

<https://www.phoenixcontact.com/in/products/1212600>



Adapter bit for TSD-M...torque tools, E6.3-1/4" drive with 4 mm hexagon to accommodate SAC bits

SAC-4P-M12MS/ 5,0-PUR/M12FS - Sensor/actuator cable



1694075

<https://www.phoenixcontact.com/in/products/1694075>

SAC BIT M12-D15 - Tool

1208432

<https://www.phoenixcontact.com/in/products/1208432>



Nut for assembling sensor/actuator cables with M12 connector and M12 connectors for assembly, with a knurl diameter of 15 mm, for 4 mm hexagonal drive

Phoenix Contact 2023 © - all rights reserved

<https://www.phoenixcontact.com>

PHOENIX CONTACT (I) Pvt. Ltd.

A-58/2, Okhla Industrial Area, Phase - II, New Delhi-110 020

+91.1275.71420

info@phoenixcontact.co.in