

SACB-4/ 8-L-10,0PUR SCO P - Sensor/actuator box



1452615

<https://www.phoenixcontact.com/in/products/1452615>

Please be informed that the data shown in this PDF document is generated from our Online Catalog. Please find the complete data in the user documentation. Our General Terms of Use for Downloads are valid.



Sensor/actuator box, application: Standard, connection method: M12-SPEEDCON-socket Plastic, number of slots: 4, number of positions: 5, coding: A, slot assignment: Double, status display: Yes, pnp; master cable connection: Fixed connection 180°, PUR/PVC, cable length: 10 m, shielding: no

Your advantages

- Safety in the field, thanks to molded housing and high degree of protection
- Convenient: increased machine availability thanks to quick and easy diagnostics
- Save space: distributor box with double occupancy for two sensors in one slot
- Save time, thanks to installation with SPEEDCON fast locking system

Commercial Data

Item number	1452615
Packing unit	1 pc
Minimum order quantity	1 pc
Sales Key	BF3
Product Key	BF3CBA
Catalog Page	Page 262 (C-2-2019)
GTIN	4046356553933
Weight per Piece (including packing)	1,489 g
Weight per Piece (excluding packing)	1,387.5 g
Customs tariff number	85444290
Country of origin	DE

SACB-4/ 8-L-10,0PUR SCO P - Sensor/actuator box



1452615

<https://www.phoenixcontact.com/in/products/1452615>

Technical Data

Notes

General	NOTE: Observe the permissible bending radii when laying conductors, since the degree of protection may be put in jeopardy if the bending forces are too high. Alleviate mechanical loads upstream of the connector, e.g. by using cable ties.
General	Unused slots are to be sealed off prior to commissioning. Suitable sealing elements are to be found under "Accessories".

Product properties

Product type	Distributor boxes with M8 to M12 slots
Number of positions	5
Application	Standard
Number of slots	4
Coding	A
LED	yes

Material specifications

Color	anthracite
Material Threaded sleeve	PBT
Material Housing	PBT
Material Molding compound	PUR
Flammability rating according to UL 94	V0
Seal material O-ring	NBR
Contact material	Cu alloy
Contact surface material	gold-plated
Contact carrier material	PA

Dimensions

Dimensional drawing	
Width	54 mm
Height	23 mm
Length	117 mm

Connection data

Conductor connection

SACB-4/ 8-L-10,0PUR SCO P - Sensor/actuator box



1452615

<https://www.phoenixcontact.com/in/products/1452615>

Connection method	Fixed connection
Tightening torque slot sensor/actuator cable	0.4 Nm
Tightening torque of mounting screw for fixing the housing	0.5 Nm

Pin assignment

Slot/position = Wire color or connection	1 / 4 (A) = WH
	1 / 2 (B) = GYPK
	2 / 4 (A) = GN
	2 / 2 (B) = RDBU
	3 / 4 (A) = YE
	3 / 2 (B) = WHGN
	4 / 4 (A) = GY
	4 / 2 (B) = BNGN
	1-4 / 1 (+ 24 V) = BN
	1-4 / 3 (0 V) = BU
1-4 / 5 (PE) = GNYE	

Signaling

Status display present	Yes
------------------------	-----

Electrical properties

Max. operating voltage U_{max}	30 V DC
Local diagnostics	Supply voltage Green LED
	Status display I/O Yellow LED
Nominal voltage U_N	24 V DC
Rated current, total	12 A
Max. current carrying capacity per path	2 A
Current carrying capacity per slot	4 A

Cable/line

Cable length	10 m
--------------	------

PUR/PVC black [PUR]

Dimensional drawing	
Cable weight	122 kg/km
UL AWM Style	20549
Number of positions	11
Shielded	no

SACB-4/ 8-L-10,0PUR SCO P - Sensor/actuator box



1452615

<https://www.phoenixcontact.com/in/products/1452615>

Cable type	PUR/PVC black [PUR]
Conductor structure signal line	28x 0.15 mm
AWG signal line	20
Conductor cross section	8x 0.5 mm ² (Signal line) 3x 1 mm ² (power line)
Wire diameter incl. insulation	1.5 mm ±0.1 mm (Signal line) 2.1 mm ±0.1 mm (power line)
External cable diameter	8.7 mm ±0.2 mm
Outer sheath, material	PUR
External sheath, color	black RAL 9005
Conductor material	Bare Cu litz wires
Material wire insulation	PVC
Single wire, color	brown, blue, green/yellow, white, green, yellow, gray, gray/pink, red/blue, white/green, brown/green
Inner sheath thickness	≥ 0.15 mm
Thickness, outer sheath	≥ 0.38 mm
Overall twist	Wires twisted in layers
Nominal voltage, cable	300 V
Test voltage	2000 V
Minimum bending radius, fixed installation	7.5 x D
Minimum bending radius, flexible installation	10 x D
Max. bending cycles	1500000
Flame resistance	DIN EN 50265
Resistance to oil	according to VDE 0472 Part 803
Other resistance	Highly resistant to acids, alkaline solutions and solvents
Special properties	Silicone-free
Ambient temperature (operation)	-40 °C ... 90 °C (cable, fixed installation) -5 °C ... 80 °C (Cable, flexible installation) 80 °C (in acc. with UL)

Standards and regulations

Standards/specifications	IEC 61076-2-101
--------------------------	-----------------

Environmental and real-life conditions

Ambient conditions

Degree of protection	IP65 IP67
Ambient temperature (operation)	-25 °C ... 80 °C

SACB-4/ 8-L-10,0PUR SCO P - Sensor/actuator box



1452615

<https://www.phoenixcontact.com/in/products/1452615>

Drawings

Circuit diagram

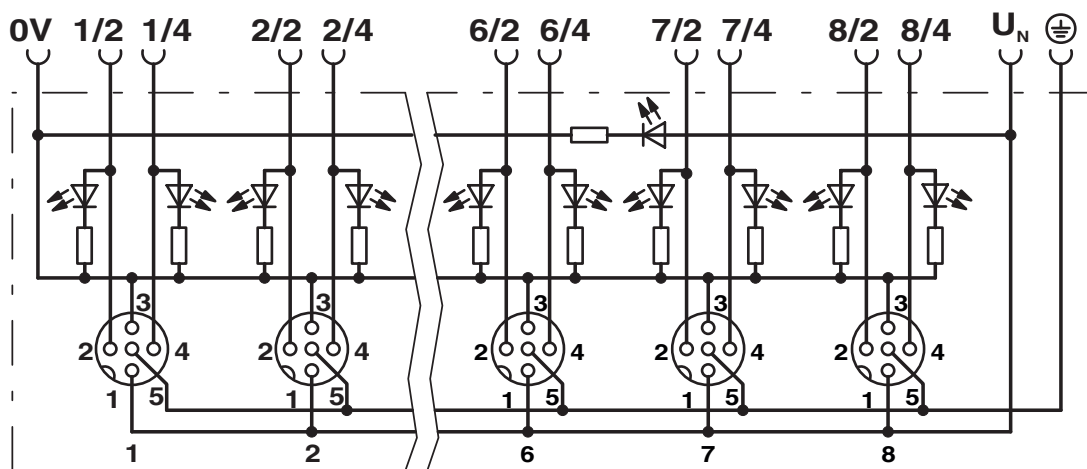

SACB-4/ 8-L-10,0PUR SCO P - Sensor/actuator box



1452615

<https://www.phoenixcontact.com/in/products/1452615>

Schematic diagram

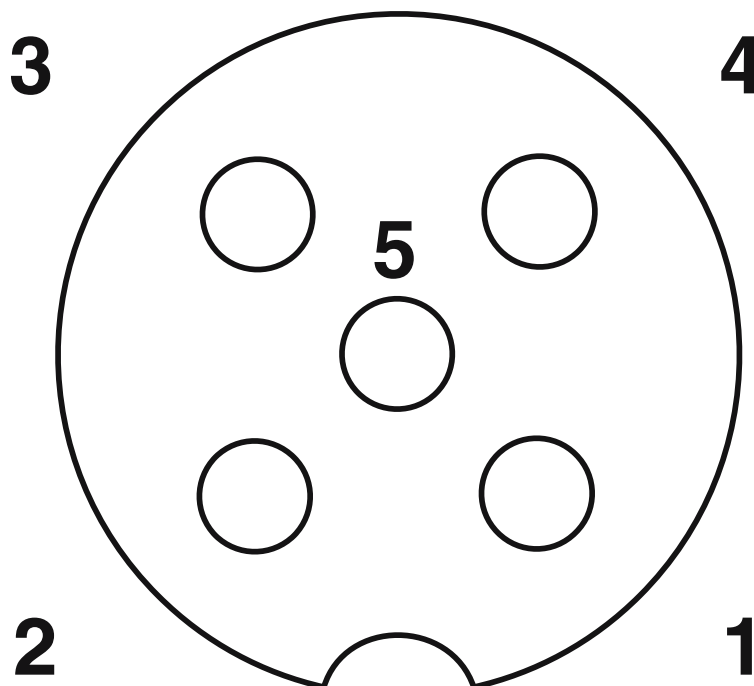

M12 slot, socket, 5-pos.

SACB-4/ 8-L-10,0PUR SCO P - Sensor/actuator box



1452615

<https://www.phoenixcontact.com/in/products/1452615>

Dimensional drawing

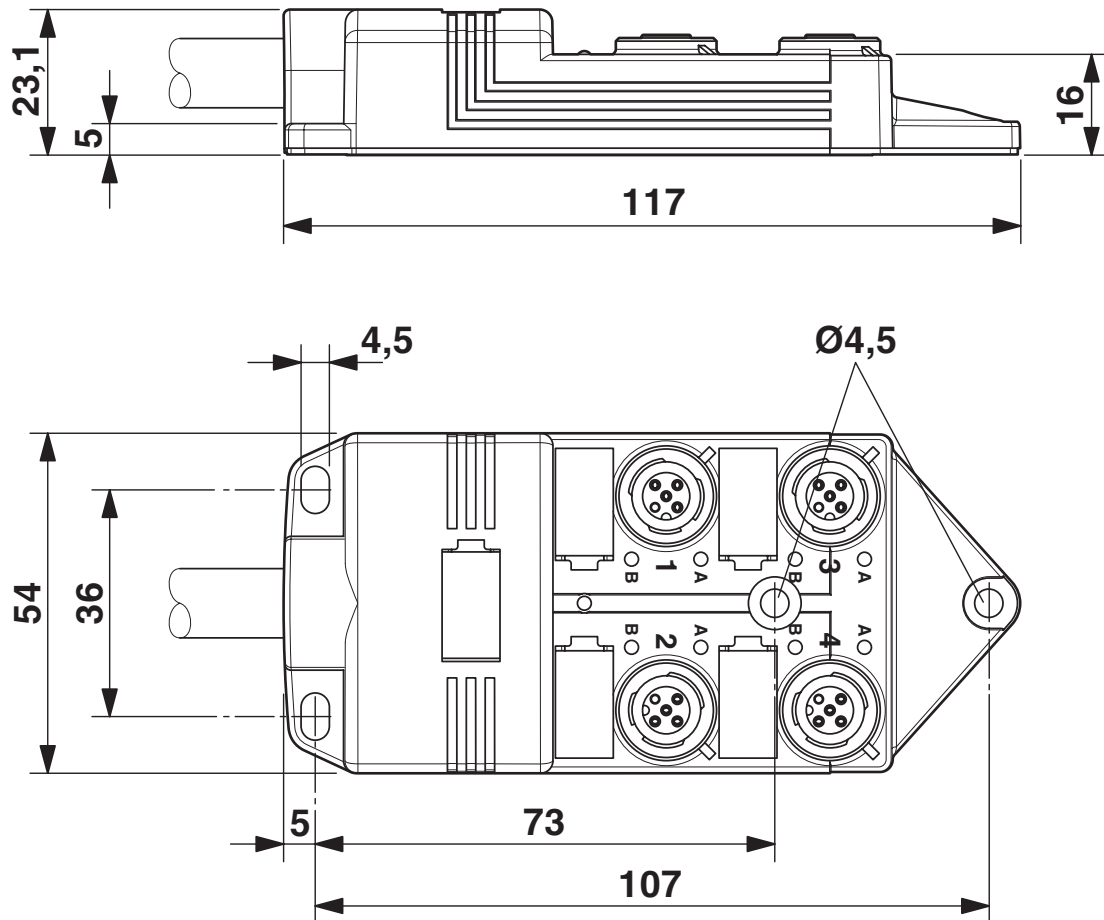

SACB-4/ 8-L-10,0PUR SCO P - Sensor/actuator box





1452615

<https://www.phoenixcontact.com/in/products/1452615>

Approvals

 cUL Recognized Approval ID: FILE E 118976				
	Nominal Voltage U_N	Nominal Current I_N	Cross Section AWG	Cross Section mm^2
	24 V	-	-	-

 UL Recognized Approval ID: FILE E 118976				
	Nominal Voltage U_N	Nominal Current I_N	Cross Section AWG	Cross Section mm^2
Signal	-	2 A	-	-
	24 V	4 A	-	-

 EAC Approval ID: RU C-DE.BL08.B.00286	
---	--

 EAC Approval ID: RU C-DE.BL08.B.00511	
---	--

SACB-4/ 8-L-10,0PUR SCO P - Sensor/actuator box



1452615

<https://www.phoenixcontact.com/in/products/1452615>

Classifications

ECLASS

ECLASS-11.0	27440108
ECLASS-12.0	27440108
ECLASS-13.0	27440108

ETIM

ETIM 8.0	EC002585
----------	----------

UNSPSC

UNSPSC 21.0	31251500
-------------	----------

SACB-4/ 8-L-10,0PUR SCO P - Sensor/actuator box



1452615

<https://www.phoenixcontact.com/in/products/1452615>

Environmental Product Compliance

China RoHS	Environmentally friendly use period: unlimited = EFUP-e
	No hazardous substances above threshold values

SACB-4/ 8-L-10,0PUR SCO P - Sensor/actuator box



1452615

<https://www.phoenixcontact.com/in/products/1452615>

Accessories

PROT-MS SCO - Screw plug

1553129

<https://www.phoenixcontact.com/in/products/1553129>



M12 screw plug with fast-locking system for unoccupied M12 female connectors of sensor/actuator cables, boxes, and flush-type connectors

TSD 04 SAC - Torque screwdriver

1208429

<https://www.phoenixcontact.com/in/products/1208429>



Torque screwdriver, with preset torque of 0.4 Nm and 4 mm hexagonal drive for M12 connectors

SACB-4/ 8-L-10,0PUR SCO P - Sensor/actuator box



1452615

<https://www.phoenixcontact.com/in/products/1452615>

TSD-M 1,2NM - Torque screwdriver

1212224

<https://www.phoenixcontact.com/in/products/1212224>



Torque screw driver, accuracy as per EN ISO 6789 standard, adjustable from 0.3 - 1.2 Nm

TSD-M SAC-BIT ADAPTER - Adapter insert

1212600

<https://www.phoenixcontact.com/in/products/1212600>



Adapter bit for TSD-M...torque tools, E6.3-1/4" drive with 4 mm hexagon to accommodate SAC bits

SACB-4/ 8-L-10,0PUR SCO P - Sensor/actuator box



1452615

<https://www.phoenixcontact.com/in/products/1452615>

SAC BIT M12-D15 - Tool

1208432

<https://www.phoenixcontact.com/in/products/1208432>



Nut for assembling sensor/actuator cables with M12 connector and M12 connectors for assembly, with a knurl diameter of 15 mm, for 4 mm hexagonal drive

SACC BIT M12-D20 - Tool

1208445

<https://www.phoenixcontact.com/in/products/1208445>



Nut for assembling M12 connectors for assembly with a knurl diameter of 20 mm, for 4 mm hexagonal drive

SACB-4/ 8-L-10,0PUR SCO P - Sensor/actuator box



1452615

<https://www.phoenixcontact.com/in/products/1452615>

UC-EM (17,5X9) - Snap-in markers

0827490

<https://www.phoenixcontact.com/in/products/0827490>



Snap-in markers, Sheet, white, unlabeled, can be labeled with: BLUEMARK ID, BLUEMARK ID COLOR, BLUEMARK CLED, BLUEMARK LED, CMS-P1-PLOTTER, PLOTMARK, mounting type: snapped, lettering field size: 17.5 x 9 mm, Number of individual labels: 20

UC-EM (17,5X9) CUS - Snap-in markers

0828238

<https://www.phoenixcontact.com/in/products/0828238>



Snap-in markers, can be ordered: by sheet, white, labeled according to customer specifications, mounting type: snapped into marker carrier, lettering field size: 17.5 x 9 mm, Number of individual labels: 20

SACB-4/ 8-L-10,0PUR SCO P - Sensor/actuator box



1452615

<https://www.phoenixcontact.com/in/products/1452615>

UCT-EM (17,5X9) - Snap-in markers

0801491

<https://www.phoenixcontact.com/in/products/0801491>



Snap-in markers, Sheet, white, unlabeled, can be labeled with: TOPMARK NEO, TOPMARK LASER, BLUEMARK ID COLOR, BLUEMARK ID, BLUEMARK CLED, THERMOMARK PRIME, THERMOMARK CARD 2.0, THERMOMARK CARD, mounting type: snapped, lettering field size: 17.5 x 9 mm, Number of individual labels: 24

UCT-EM (17,5X9) CUS - Snap-in markers

0801575

<https://www.phoenixcontact.com/in/products/0801575>



UniCard sheet, for labeling devices from other manufacturers, for overview table see download area, labeled according to customer specifications

SACB-4/ 8-L-10,0PUR SCO P - Sensor/actuator box



1452615

<https://www.phoenixcontact.com/in/products/1452615>

UC-EM (17,5X9) YE - Snap-in markers

0827494

<https://www.phoenixcontact.com/in/products/0827494>

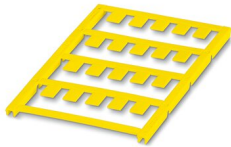

Snap-in markers, Sheet, yellow, unlabeled, can be labeled with: BLUEMARK ID COLOR, BLUEMARK ID, BLUEMARK CLED, PLOTMARK, CMS-P1-PLOTTER, mounting type: snapped, lettering field size: 17.5 x 9 mm, Number of individual labels: 20

UC-EM (17,5X9) YE CUS - Snap-in markers

0828239

<https://www.phoenixcontact.com/in/products/0828239>

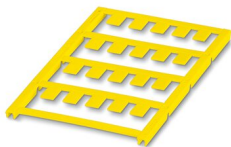

Snap-in markers, can be ordered: by sheet, yellow, labeled according to customer specifications, mounting type: snapped into marker carrier, lettering field size: 17.5 x 9 mm, Number of individual labels: 20

SACB-4/ 8-L-10,0PUR SCO P - Sensor/actuator box



1452615

<https://www.phoenixcontact.com/in/products/1452615>

UCT-EM (17,5X9) YE - Snap-in markers

0801492

<https://www.phoenixcontact.com/in/products/0801492>



Snap-in markers, Sheet, yellow, unlabeled, can be labeled with: TOPMARK NEO, TOPMARK LASER, BLUEMARK ID COLOR, BLUEMARK ID, BLUEMARK CLED, THERMOMARK PRIME, THERMOMARK CARD 2.0, THERMOMARK CARD, mounting type: snapped, lettering field size: 17.5 x 9 mm, Number of individual labels: 24

UCT-EM (17,5X9) YE CUS - Snap-in markers

0801576

<https://www.phoenixcontact.com/in/products/0801576>



UniCard sheet, for labeling devices from other manufacturers, for overview table see download area, labeled according to customer specifications

SACB-4/ 8-L-10,0PUR SCO P - Sensor/actuator box

1452615

<https://www.phoenixcontact.com/in/products/1452615>



UTA 107 - DIN rail adapter

2853983

<https://www.phoenixcontact.com/in/products/2853983>

Universal DIN rail adapter, for screwing on switchgear

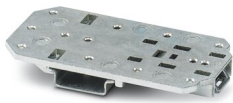

Phoenix Contact 2023 © - all rights reserved

<https://www.phoenixcontact.com>

PHOENIX CONTACT (I) Pvt. Ltd.

A-58/2, Okhla Industrial Area, Phase - II, New Delhi-110 020

+91.1275.71420

info@phoenixcontact.co.in