

HC-EVO-B24PT-BWSC-HH-M32-PLRBK - Connector set



1408794

<https://www.phoenixcontact.com/in/products/1408794>

Please be informed that the data shown in this PDF document is generated from our Online Catalog. Please find the complete data in the user documentation. Our General Terms of Use for Downloads are valid.



EVO connector set, B24 series, plastic housing, consisting of sleeve housing, panel mounting base, push-in contact inserts: 1407735, 1407736, 1407660, 1407656, 1407671

Your advantages

- Lower costs than metal version
- Labeling option using 9 x 20 mm marking label
- Low weight
- Lower risk of condensation

Commercial Data

Item number	1408794
Packing unit	1 pc
Minimum order quantity	1 pc
Sales Key	BF7
Product Key	BF7AFX
Catalog Page	Page 646 (C-2-2019)
GTIN	4046356834117
Weight per Piece (including packing)	615.8 g
Weight per Piece (excluding packing)	615.8 g
Customs tariff number	85366990
Country of origin	CN

HC-EVO-B24PT-BWSC-HH-M32-PLRBK - Connector set



1408794

<https://www.phoenixcontact.com/in/products/1408794>

Set consists of

HC-B24-I-PT-F - Contact insert

1407735

<https://www.phoenixcontact.com/in/products/1407735>



Contact insert, number of positions: 24+PE, size: B24, number of connections per position: 1, Socket, Push-in connection, 500 V, 16 A, 0.14 mm² ... 2.5 mm², application: Power

HC-B24-I-PT-M - Contact insert

1407736

<https://www.phoenixcontact.com/in/products/1407736>

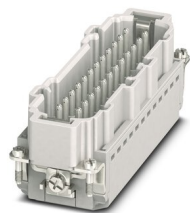

Contact insert, number of positions: 24+PE, size: B24, number of connections per position: 1, Pin, Push-in connection, 500 V, 16 A, 0.14 mm² ... 2.5 mm², application: Power

HC-EVO-B24PT-BWSC-HH-M32-PLRBK - Connector set



1408794

<https://www.phoenixcontact.com/in/products/1408794>

HC-EVO-B24-BWSC-PLRBK - Housing

1407660

<https://www.phoenixcontact.com/in/products/1407660>



Panel mounting base B24, with single locking latch, material: PA, protective cover material: PC, height: 30.5 mm, cable gland: none, protective cover: yes, Standard, with flat gasket

HC-EVO-B24-HHFS-PLBK - Housing

1407656

<https://www.phoenixcontact.com/in/products/1407656>



HEAVYCON EVO sleeve housing, plastic, with bayonet flange for EVO screw connection, B24, for single locking latch, height: 87.5 mm, without EVO screw connection

HC-EVO-B24PT-BWSC-HH-M32-PLRBK - Connector set



1408794

<https://www.phoenixcontact.com/in/products/1408794>

HC-B-G-M32-PLRBK - Cable gland

1407671

<https://www.phoenixcontact.com/in/products/1407671>



EVO plastic cable gland with bayonet locking, for housing series B, size M32, cable diameter: 11 mm ... 21 mm

HC-EVO-B24PT-BWSC-HH-M32-PLRBK - Connector set



1408794

<https://www.phoenixcontact.com/in/products/1408794>

Technical Data

Notes

General	Connectors may be operated only when there is no load/voltage.
---------	--

Product properties

Type	B24
Product type	Connector set
Number of positions	24
Connection profile	24+PE
Contact numbering	1 - 24
No. of cable outlets	1
Type of the screw connection	1x M32
Housing type	Complete housing
Protective cover	yes
Locking type	Single locking latch
Series	HC-B
Cable outlet	straight
Pg screw connection	none

Insulation characteristics

Overvoltage category	III
Degree of pollution	3

Electrical properties

Rated voltage (III/3)	500 V
Rated surge voltage	6 kV
Rated current	16 A

Connection data

Connection method	Push-in connection
Connection technology	Push-in connection
Conductor cross section	0.14 mm ² ... 2.5 mm ² (with ferrule) 0.14 mm ² ... 2.5 mm ² (with ferrule)
Connection cross section AWG	26 ... 14 (with ferrule)
Tightening torque	0.5 Nm ... 1.7 Nm (Fixing screws for panel mounting base)
Stripping length	8 mm ... 10 mm

Dimensions

Dimensional drawing

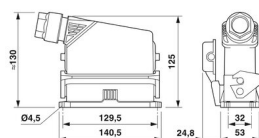

HC-EVO-B24PT-BWSC-HH-M32-PLRBK - Connector set



1408794

<https://www.phoenixcontact.com/in/products/1408794>

Width	53 mm
Height	130 mm
Length	140.5 mm
Drill hole distance, horizontal	129.5 mm
Drill hole distance, vertical	32 mm

Installation dimensions

Width of the assembly cutout	35 mm
Length of the assembly cutout	113 mm

Material specifications

Material Protective cover	PA
Flammability rating according to UL 94	V0
Seal material Profile gasket	NBR
Seal material Flat gasket	NBR
Contact material	Copper alloy
Contact surface material	Ag
Contact carrier material	PA
Locking latch material	PA
Impact strength	IK09
Housing material	PA

Cable/line

External cable diameter	11 mm ... 21 mm
-------------------------	-----------------

Mechanical properties

Mechanical data

Type of the screw connection	1x M32
Locking type	Latch
Insertion/withdrawal cycles	≥ 500

Environmental and real-life conditions

Ambient conditions

Degree of protection	IP66
	12 (UL 50e)
Impact strength	IK09
Ambient temperature (operation)	-40 °C ... 100 °C

Mounting

Assembly instructions	Coding also using the CP-HC (1686478) coding profiles. HC-B6.. / HC-B10..for two coding profiles. HC-B16.. / HC-B24..for four coding profiles. Connectors may only be operated when there is no load/the power is switched off. Can be used for solid wires and stranded wires with ferrule.
-----------------------	---

HC-EVO-B24PT-BWSC-HH-M32-PLRBK - Connector set



1408794

<https://www.phoenixcontact.com/in/products/1408794>

Connection method	Push-in connection
-------------------	--------------------

HC-EVO-B24PT-BWSC-HH-M32-PLRBK - Connector set



1408794

<https://www.phoenixcontact.com/in/products/1408794>

Drawings

Schematic diagram

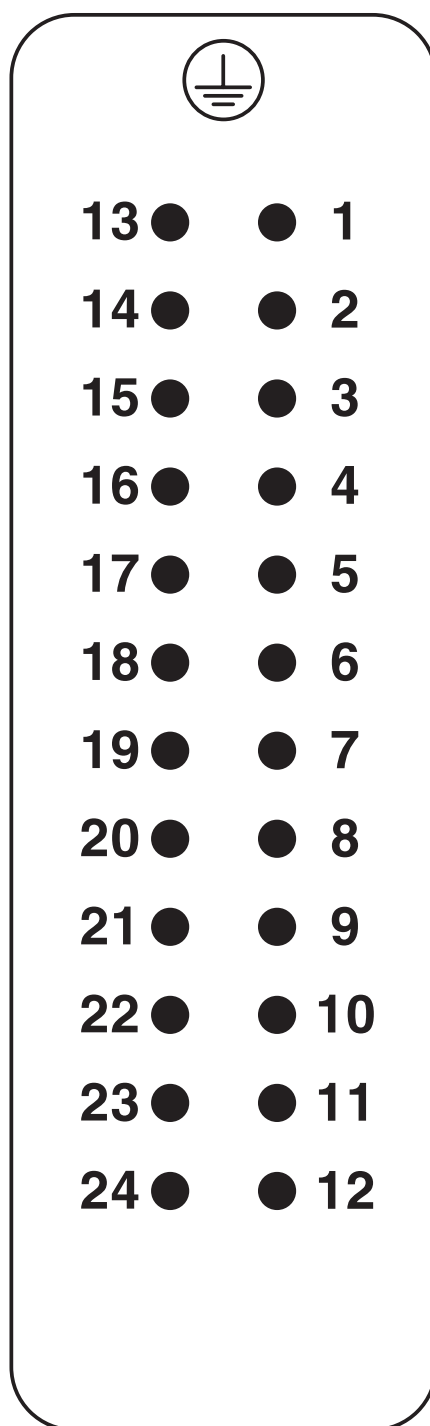

Pin assignment, connection side, pin

HC-EVO-B24PT-BWSC-HH-M32-PLRBK - Connector set



1408794

<https://www.phoenixcontact.com/in/products/1408794>

Dimensional drawing

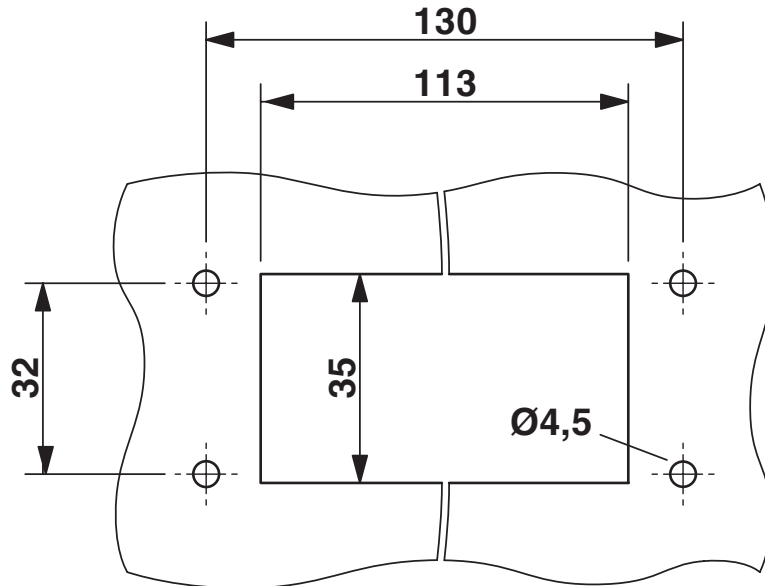

Mounting cutout

Dimensional drawing

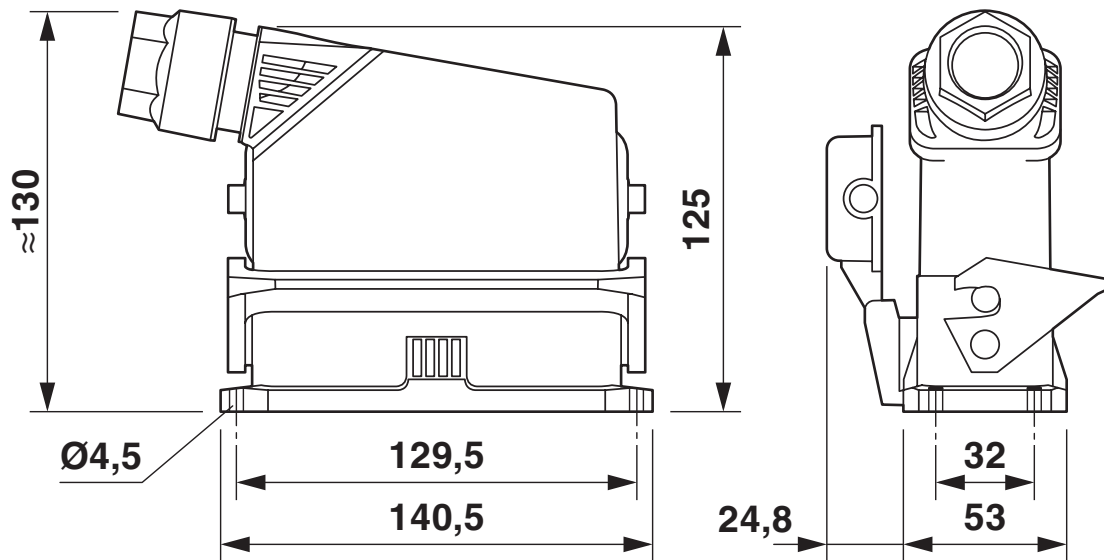

Dimensional drawing

HC-EVO-B24PT-BWSC-HH-M32-PLRBK - Connector set



1408794

<https://www.phoenixcontact.com/in/products/1408794>

Schematic diagram

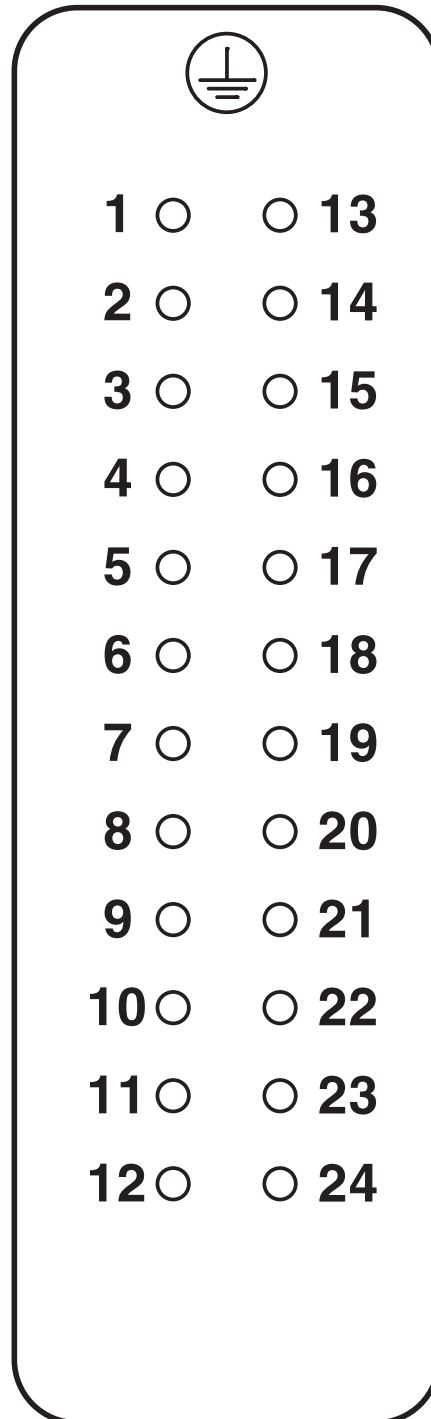

Pin assignment, connection side, socket

HC-EVO-B24PT-BWSC-HH-M32-PLRBK - Connector set



1408794

<https://www.phoenixcontact.com/in/products/1408794>

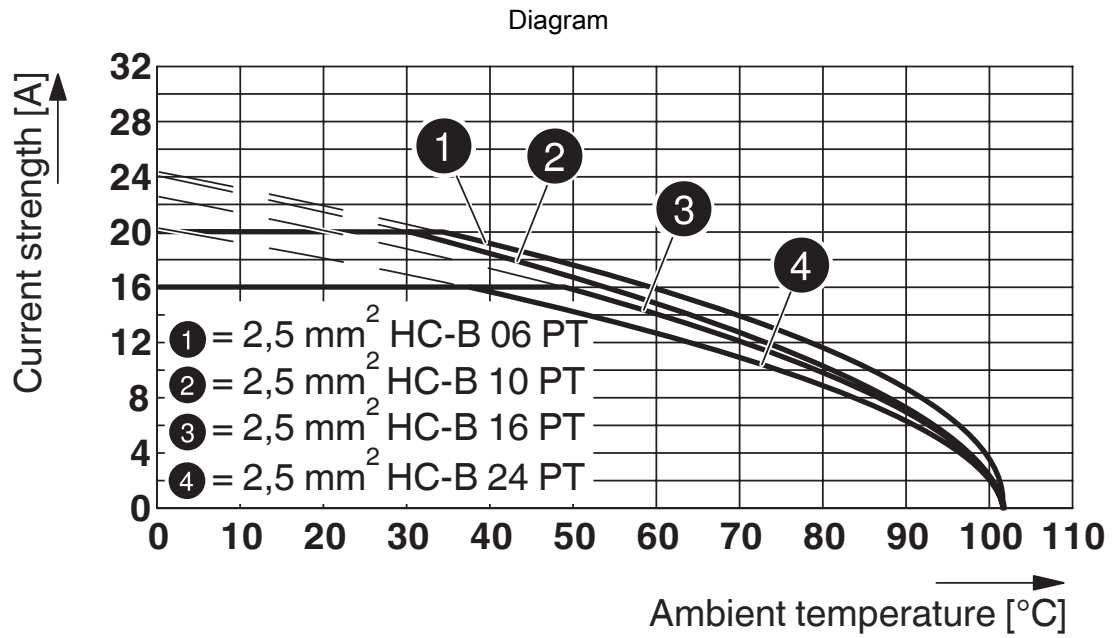

Derating diagram

HC-EVO-B24PT-BWSC-HH-M32-PLRBK - Connector set



1408794

<https://www.phoenixcontact.com/in/products/1408794>

Approvals



EAC

Approval ID: RU C-DE.BL08.B.00511

HC-EVO-B24PT-BWSC-HH-M32-PLRBK - Connector set



1408794

<https://www.phoenixcontact.com/in/products/1408794>

Classifications

ECLASS

ECLASS-11.0	27440101
ECLASS-12.0	27440113
ECLASS-13.0	27440113

ETIM

ETIM 8.0	EC002636
----------	----------

UNSPSC

UNSPSC 21.0	39121400
-------------	----------

HC-EVO-B24PT-BWSC-HH-M32-PLRBK - Connector set



1408794

<https://www.phoenixcontact.com/in/products/1408794>

Environmental Product Compliance

China RoHS	Environmentally friendly use period: unlimited = EFUP-e
	No hazardous substances above threshold values

HC-EVO-B24PT-BWSC-HH-M32-PLRBK - Connector set



1408794

<https://www.phoenixcontact.com/in/products/1408794>

Accessories

HC-B24-SL-PLBK - Housing brackets

1407701

<https://www.phoenixcontact.com/in/products/1407701>



Replacement single locking latch for HEAVYCON EVO housing type B24, PA

US-EMP (20X9) - Snap-in markers

0829439

<https://www.phoenixcontact.com/in/products/0829439>



Snap-in markers, Card, white, unlabeled, can be labeled with: BLUEMARK ID COLOR, BLUEMARK ID, THERMOMARK PRIME, THERMOMARK CARD 2.0, THERMOMARK CARD, mounting type: snapped, lettering field size: 20 x 9 mm, Number of individual labels: 70

Phoenix Contact 2023 © - all rights reserved

<https://www.phoenixcontact.com>

PHOENIX CONTACT (I) Pvt. Ltd.

A-58/2, Okhla Industrial Area, Phase - II, New Delhi-110 020

+91.1275.71420

info@phoenixcontact.co.in