

SACB-8/16-L-PT QO - Sensor/actuator box



1175449

<https://www.phoenixcontact.com/in/products/1175449>

Please be informed that the data shown in this PDF document is generated from our Online Catalog. Please find the complete data in the user documentation. Our General Terms of Use for Downloads are valid.



Sensor/actuator box, connection method: QUICKON, 0.14 mm² ... 0.75 mm², number of slots: 8, number of positions: 5, slot assignment: Double, status display: Yes, pnp; master cable connection: Push-in connection 180°, shielding: no, When connecting 5 conductors, max. 0.5 mm² can be connected

Your advantages

- Safety in the field, thanks to molded housing and high degree of protection
- Convenient: increased machine availability thanks to quick and easy diagnostics
- Innovative and time-saving assembly with insulation displacement connection
- Flexible: distributor box with connector hood for on-site assembly

Commercial Data

Item number	1175449
Packing unit	1 pc
Minimum order quantity	1 pc
Sales Key	BF3
Product Key	BF3DBC
GTIN	4063151205225
Weight per Piece (including packing)	386.4 g
Weight per Piece (excluding packing)	386 g
Customs tariff number	85366990
Country of origin	DE

Technical Data

Notes

General	NOTE: Observe the permissible bending radii when laying conductors, since the degree of protection may be put in jeopardy if the bending forces are too high. Alleviate mechanical loads upstream of the connector, e.g. by using cable ties.
General	Unused slots are to be sealed off prior to commissioning. Suitable sealing elements are to be found under "Accessories".

Product properties

Product type	Distributor box with fast connection method
Number of positions	5
Number of slots	8
LED	yes

System properties

Local diagnostics

Monitored function	Supply voltage per module
Optical representation	Green LED

Electrical properties

Max. operating voltage U_{max}	30 V DC
Local diagnostics	Supply voltage per module Green LED
	Status display I/O Yellow LED
Nominal voltage U_N	24 V DC
Rated current, total	10 A
Max. current carrying capacity per path	2 A
Current carrying capacity per slot	4 A

Connection data

Conductor connection

Connection method	Push-in connection
Stripping length	8 mm
Conductor cross section Flexible signal line	0.2 mm ² ... 1.5 mm ²
Conductor cross section Flexible power supply	0.2 mm ² ... 1.5 mm ²
Connection cross section AWG Flexible signal line	24 ... 16
Connection cross section AWG Flexible power supply	24 ... 16
Tightening torque, cover screw	0.35 Nm
Tightening torque of mounting screw for fixing the housing	0.5 Nm

Pin assignment

Slot/position = Wire color or connection	1 / 4 (A) = 1 / 4
	1 / 2 (B) = 1 / 2

SACB-8/16-L-PT QO - Sensor/actuator box



1175449

<https://www.phoenixcontact.com/in/products/1175449>

	2 / 4 (A) = 2 / 4
	2 / 2 (B) = 2 / 2
	3 / 4 (A) = 3 / 4
	3 / 2 (B) = 3 / 2
	4 / 4 (A) = 4 / 4
	4 / 2 (B) = 4 / 2
	5 / 4 (A) = 5 / 4
	5 / 2 (B) = 5 / 2
	6 / 4 (A) = 6 / 4
	6 / 2 (B) = 6 / 2
	7 / 4 (A) = 7 / 4
	7 / 2 (B) = 7 / 2
	8 / 4 (A) = 8 / 4
	8 / 2 (B) = 8 / 2
	1-8 / 1 (+ 24 V) = U _N
	1-8 / 3 (0 V) = 0 V
	1-8 / 5 (PE) = PE

Signaling

Status display present	Yes
------------------------	-----

Dimensions

Dimensional drawing	
Width	58 mm
Height	45 mm
Length	168 mm
Wrench size, union nut	16 mm

Material specifications

Color	black
Material Housing	PBT
Material Molding compound	PUR
Flammability rating according to UL 94	V0
Seal material O-ring	FKM
Seal material	FKM
Contact material	Steel/copper
Contact surface material	Sn

SACB-8/16-L-PT QO - Sensor/actuator box



1175449

<https://www.phoenixcontact.com/in/products/1175449>

Contact carrier material	PA 6.6
Material of contact, master cable side	CU alloy
Material of the contact carrier on the master cable side	PA 6.6 V0
Material of contact surface, master cable side	Sn

Conductor data

Wire insulation material	PVC / PE / PP / rubber
--------------------------	------------------------

Cable/line

Sensor/actuator connection system	QUICKON
Connection method	Push-in connection
External cable diameter	7 mm ... 12 mm
Metric conductor cross section (Signal)	0.2 mm ² ... 1.5 mm ²
Cross section AWG (Signal)	24 ... 16
Stripping length (signal)	8 mm
Metric conductor cross section (Power)	0.2 mm ² ... 1.5 mm ²
Cross section AWG (Power)	24 ... 16
Stripping length for sheath	50 mm (Master cable)
Tightening torque, cover screw	0.35 Nm
Tightening torque of mounting screw for fixing the housing	0.5 Nm
Tightening torque, union nut	2.5 Nm

Environmental and real-life conditions

Ambient conditions

Degree of protection	IP65
Ambient temperature (operation)	-30 °C ... 80 °C
	-5 °C ... 50 °C (During assembly)

SACB-8/16-L-PT QO - Sensor/actuator box



1175449

<https://www.phoenixcontact.com/in/products/1175449>

Drawings

Dimensional drawing

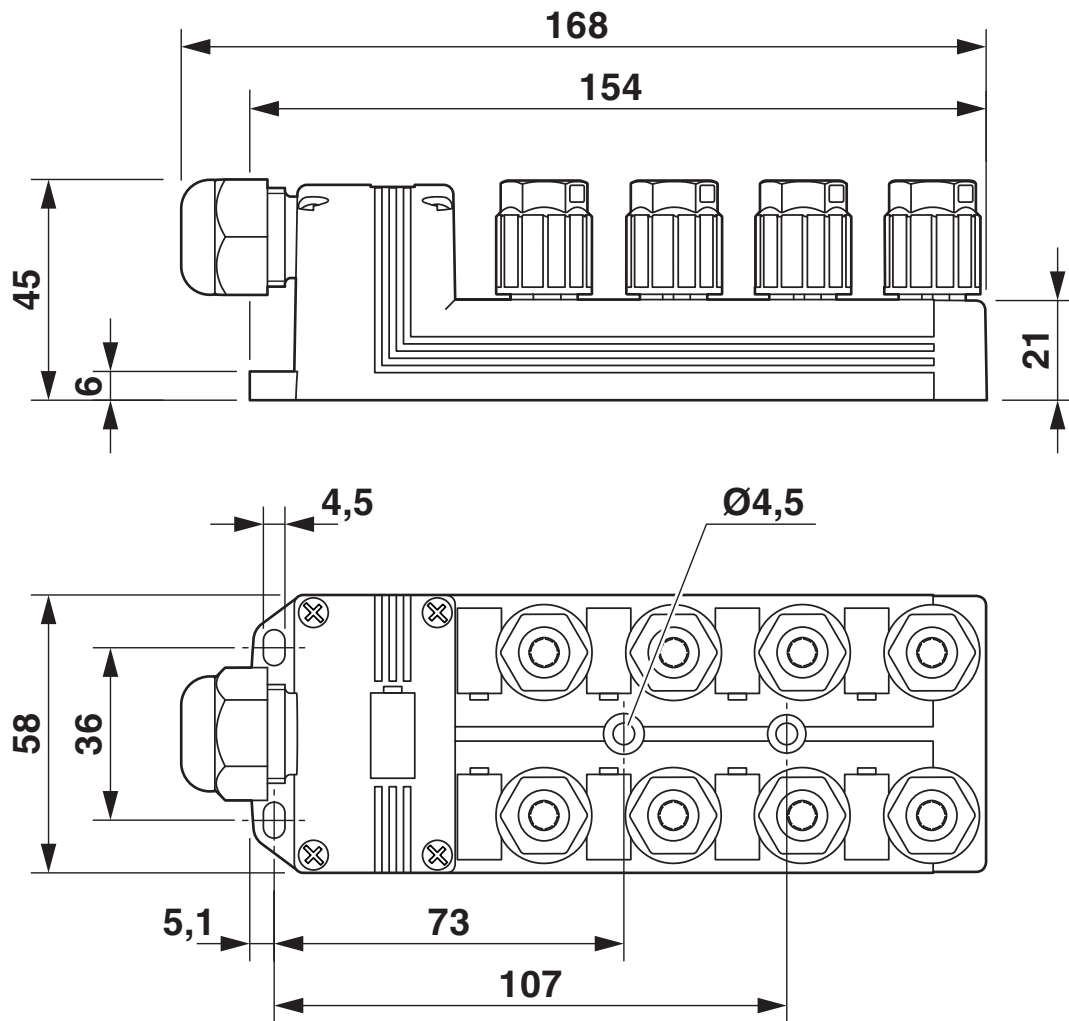

SACB-8/16-L-PT QO - Sensor/actuator box

1175449

<https://www.phoenixcontact.com/in/products/1175449>

Functional drawing

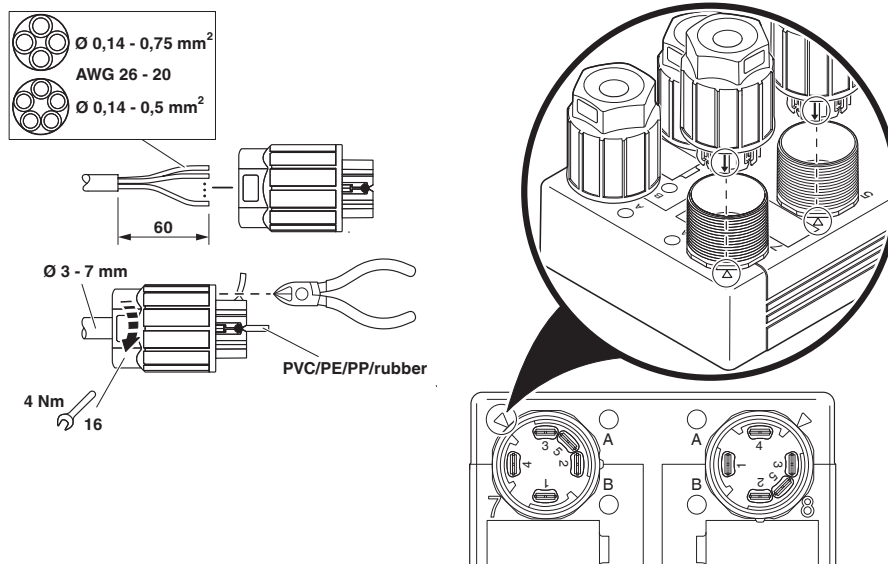

Schematic diagram

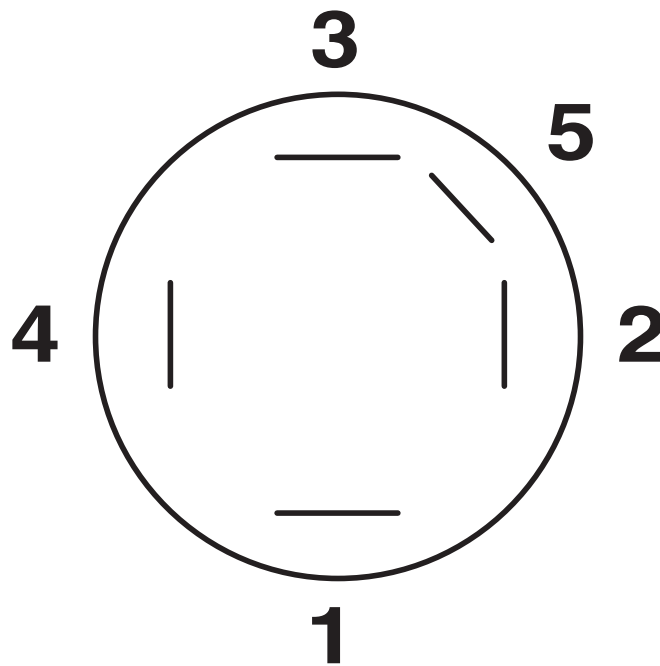

QUICKON connection, 5-pos.

SACB-8/16-L-PT QO - Sensor/actuator box



1175449

<https://www.phoenixcontact.com/in/products/1175449>

Circuit diagram

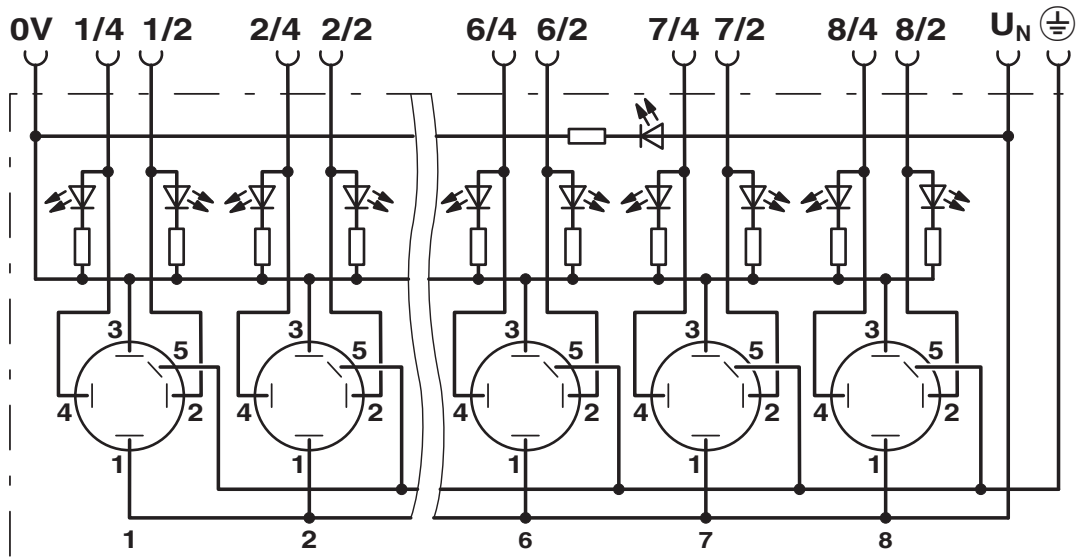

SACB-8/16-L-PT QO - Sensor/actuator box



1175449

<https://www.phoenixcontact.com/in/products/1175449>

Classifications

ECLASS

ECLASS-11.0	27440111
ECLASS-12.0	27440111
ECLASS-13.0	27440111

ETIM

ETIM 8.0	EC003558
----------	----------

UNSPSC

UNSPSC 21.0	31251500
-------------	----------

SACB-8/16-L-PT QO - Sensor/actuator box



1175449

<https://www.phoenixcontact.com/in/products/1175449>

Environmental Product Compliance

China RoHS	Environmentally friendly use period: unlimited = EFUP-e
	No hazardous substances above threshold values

SACB-8/16-L-PT QO - Sensor/actuator box



1175449

<https://www.phoenixcontact.com/in/products/1175449>

Accessories

SACB- 8X0,34/2X0,75-50 PUR - Master cable ring

1517592

<https://www.phoenixcontact.com/in/products/1517592>



Master cable for sensor/actuator boxes, without PE conductor, unshielded, material PUR/PVC, 10-pos., 8 x 0.34 mm² and 2 x 0.75 mm², length: 50 m

Q-PROT 9/11 - Filler plugs

1670235

<https://www.phoenixcontact.com/in/products/1670235>



Closing cap for Pg9/Pg11 to close unoccupied connections

SACB-8/16-L-PT QO - Sensor/actuator box



1175449

<https://www.phoenixcontact.com/in/products/1175449>

SACB-QO SET - Screw connection set

1293751

<https://www.phoenixcontact.com/in/products/1293751>



QUICKON set for replacement purposes, consisting of splice ring, pressure nut and line seal

UC-EM (17,5X9) - Snap-in markers

0827490

<https://www.phoenixcontact.com/in/products/0827490>



Snap-in markers, Sheet, white, unlabeled, can be labeled with: BLUEMARK ID, BLUEMARK ID COLOR, BLUEMARK CLED, BLUEMARK LED, CMS-P1-PLOTTER, PLOTMARK, mounting type: snapped, lettering field size: 17.5 x 9 mm, Number of individual labels: 20

SACB-8/16-L-PT QO - Sensor/actuator box



1175449

<https://www.phoenixcontact.com/in/products/1175449>

UC-EM (17,5X9) CUS - Snap-in markers

0828238

<https://www.phoenixcontact.com/in/products/0828238>



Snap-in markers, can be ordered: by sheet, white, labeled according to customer specifications, mounting type: snapped into marker carrier, lettering field size: 17.5 x 9 mm, Number of individual labels: 20

UCT-EM (17,5X9) - Snap-in markers

0801491

<https://www.phoenixcontact.com/in/products/0801491>



Snap-in markers, Sheet, white, unlabeled, can be labeled with: TOPMARK NEO, TOPMARK LASER, BLUEMARK ID COLOR, BLUEMARK ID, BLUEMARK CLED, THERMOMARK PRIME, THERMOMARK CARD 2.0, THERMOMARK CARD, mounting type: snapped, lettering field size: 17.5 x 9 mm, Number of individual labels: 24

SACB-8/16-L-PT QO - Sensor/actuator box



1175449

<https://www.phoenixcontact.com/in/products/1175449>

UCT-EM (17,5X9) CUS - Snap-in markers

0801575

<https://www.phoenixcontact.com/in/products/0801575>

UniCard sheet, for labeling devices from other manufacturers, for overview table see download area, labeled according to customer specifications



UC-EM (17,5X9) YE - Snap-in markers

0827494

<https://www.phoenixcontact.com/in/products/0827494>

Snap-in markers, Sheet, yellow, unlabeled, can be labeled with: BLUEMARK ID COLOR, BLUEMARK ID, BLUEMARK CLED, PLOTMARK, CMS-P1-PLOTTER, mounting type: snapped, lettering field size: 17.5 x 9 mm, Number of individual labels: 20

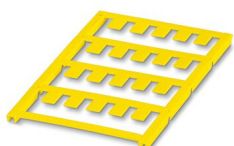

SACB-8/16-L-PT QO - Sensor/actuator box



1175449

<https://www.phoenixcontact.com/in/products/1175449>

UC-EM (17,5X9) YE CUS - Snap-in markers

0828239

<https://www.phoenixcontact.com/in/products/0828239>

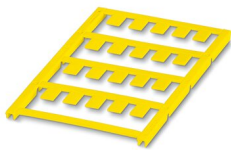

Snap-in markers, can be ordered: by sheet, yellow, labeled according to customer specifications, mounting type: snapped into marker carrier, lettering field size: 17.5 x 9 mm, Number of individual labels: 20

UCT-EM (17,5X9) YE - Snap-in markers

0801492

<https://www.phoenixcontact.com/in/products/0801492>

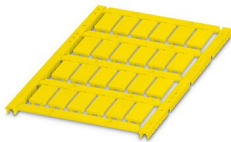

Snap-in markers, Sheet, yellow, unlabeled, can be labeled with: TOPMARK NEO, TOPMARK LASER, BLUEMARK ID COLOR, BLUEMARK ID, BLUEMARK CLED, THERMOMARK PRIME, THERMOMARK CARD 2.0, THERMOMARK CARD, mounting type: snapped, lettering field size: 17.5 x 9 mm, Number of individual labels: 24

SACB-8/16-L-PT QO - Sensor/actuator box

1175449

<https://www.phoenixcontact.com/in/products/1175449>



UCT-EM (17,5X9) YE CUS - Snap-in markers

0801576

<https://www.phoenixcontact.com/in/products/0801576>

UniCard sheet, for labeling devices from other manufacturers, for overview table see download area, labeled according to customer specifications



SZK PZ1 VDE - Screwdriver

1206450

<https://www.phoenixcontact.com/in/products/1206450>

Screwdriver, PZ crosshead, VDE insulated, size: PZ 1 x 80 mm, 2-component grip, with non-slip grip



SACB-8/16-L-PT QO - Sensor/actuator box



1175449

<https://www.phoenixcontact.com/in/products/1175449>

TSD 25 SAC - Torque screwdriver

1212315

<https://www.phoenixcontact.com/in/products/1212315>



Torque screwdriver, with preset torque of 2.5 Nm and 4 mm hexagonal drive for the pressure nut of the connector hood

SAC BIT HOOD-W 24 - Tool

1212486

<https://www.phoenixcontact.com/in/products/1212486>



Nut for assembling pressure nuts with 24 mm wrench size, for 4 mm hexagonal drive

SACB-8/16-L-PT QO - Sensor/actuator box



1175449

<https://www.phoenixcontact.com/in/products/1175449>

SF-BIT-PZ 1-50 - Screw insert

1212591

<https://www.phoenixcontact.com/in/products/1212591>



Screw bit, PZ crosshead, E6.3-1/4" drive, size: PZ 1 x 50 mm, hardened, suitable for holder according to DIN 3126-F6.3/ISO 1173

UTA 136 - DIN rail adapter

2853996

<https://www.phoenixcontact.com/in/products/2853996>

Universal DIN rail adapter, for screwing on switchgear



Phoenix Contact 2023 © - all rights reserved

<https://www.phoenixcontact.com>

PHOENIX CONTACT (I) Pvt. Ltd.

A-58/2, Okhla Industrial Area, Phase - II, New Delhi-110 020

+91.1275.71420

info@phoenixcontact.co.in